

# BRASCH

# Electric

---

# Duct

---

# Heaters

---



# Index

|                                       |       |  |       |
|---------------------------------------|-------|--|-------|
| Bottom Insert . . . . .               | 11    | Raintight Construction . . . . .         | 11    |
| Bottom Outlet . . . . .               | 12    | Recessed Terminal Box. . . . .           | 10    |
| Construction Details . . . . .        | 6, 7  | Round-Duct Construction . . . . .        | 14    |
| Dusttight Heaters. . . . .            | 10    | SCRs . . . . .                           | 8     |
| Express Duct Heaters. . . . .         | 27    | SCR-Vernier . . . . .                    | 8     |
| Finned Tubular Construction . . . . . | 15    | Single Zone. . . . .                     | 16    |
| Flanged Construction . . . . .        | 5     | Sizes and KW Ratings . . . . .           | 3     |
| Installation . . . . .                | 5     | Slip-in Construction . . . . .           | 5     |
| Insulated Terminal Box . . . . .      | 12    | Specification, Sample. . . . .           | 4     |
| Multizone . . . . .                   | 16    | Step Controllers. . . . .                | 8     |
| NEC Requirements . . . . .            | 24-26 | Technical Data. . . . .                  | 16    |
| Oven Heaters . . . . .                | 13    | Thermostats . . . . .                    | 9     |
| Pressure Drop Graph . . . . .         | 18    | Wiring Diagrams-Control Systems. . . . . | 20-23 |
| Protective Screens. . . . .           | 13    | UL . . . . .                             | 3     |
| Quality Control. . . . .              | 3     |  |       |

# Ratings and Sizes

You specify it—we build it! Heaters described in this bulletin are custom designed at no extra charge to your exact size, wattage, voltage and phase and number of steps. Any duct size from W = 5" and H = 4" minimum to W = 480" and H = 180" maximum, wattages to 2000 KW can be furnished. Base price depends upon duct size and KW rating; base price is the same for single or three phase and does not change with number of steps.

For practical design of heater, minimum recommended KW per step is .5 KW for 208V single phase; 1.0 KW for 277V or 480V single phase and 2.0 KW for 480V or 600V three phase.

# UL Listing

UL Listed by Underwriters Laboratories, Inc. under File Nos. E 39836 and E39386 for zero clearance between heater and combustible surfaces. Listing includes all built-in components unless otherwise noted. Heaters are also UL Listed for use with heat pumps and air conditioners when mounted 4 feet or more from unit and maximum inlet air temperature is 100°F.

# Quality Control

Heaters are dielectrically tested for 1000V plus twice the rated voltage or 2000V, whichever is higher. The resistance of each heater is measured and recorded and must be within 5% of rated value. Electrical components are tested and inspected after installation in the heater. Every heater is checked twice; once in production and once by a trained Quality Control inspector who gives each heater a thorough inspection.

## Suggested Schedule for Electric Heating Coils

| Tag NO.    | Inside Duct Size W' x H' | CFM (Min.) | KW   | Voltage/Phase | No. of Steps | Control Volts | Type of Control | Horizontal or Vertical Airflow Direction | Special Features              |
|------------|--------------------------|------------|------|---------------|--------------|---------------|-----------------|--|-------------------------------|
| EH-1 to 10 | 12 x 8                   | 430        | 5.0  | 480/3         | 2            | 24            | PE              |  | Direct Acting                 |
| EH-11      | 18 x 12                  | 750        | 21.5 | 480/3         | 1            | 24            | SCR             | HAF                                      | Direct Acting Transducer      |
| AH-1       | —                        | 5000       | 85.0 | 480/3         | 6            | 24            | Step Control    |  | Preheat for Carrier 39BA120-B |

# Sample Specification-Open Coil - Finned Tubular

General: Electric duct heaters and air handling coils shall be as manufactured by Brasch Manufacturing Company, Inc. Voltage, size, KW, steps and control voltage shall be as scheduled. Three phase heaters shall have balanced phases.

1. Heaters shall be UL Listed for zero clearance and shall meet all NEC requirements.
2. Type: Heaters shall be of the following configuration:  
For Duct Mounting . . . . . All Slip-in or Flanged  
For Air Handling Unit Coils . . . . . All Slip-in or Flanged  
Multizone Hot Deck Coils . . . . . Slip-in Type
3. Open coil heating elements shall be 80% nickel and 20% chromium; steps shall be arranged to prevent stratification when operating at less than full capacity. Elements for draw-through air handling units shall be derated to 35 watts per square inch; blow-through air handling coils and variable volume reheat coils shall be derated to 25 watts per square inch.
4. Element terminals shall be stainless steel; insulators and bracket bushings shall be nonporous ceramic and securely positioned. Terminals shall be machine crimped to elements.
5. Elements for Finned Tubular heaters shall have steel fins brazed to copper plated sheath. Element wire shall be 80/20 Nichrome. Elements shall be protected against corrosion by a high-temperature aluminum coating. Terminals shall be sealed with silicone rubber to protect against moisture.
6. Frame shall be constructed of heavy gauge galvanized steel with galvanized steel brackets, stiffening ribs and gussets spot welded to the frame.
7. Terminal box shall be spot welded construction with solid, hinged cover, totally enclosed, without louvers or grilles per the UL Standard.
8. Recessed terminal box to be provided when coils are installed in ducts with internal insulation or obstruction greater than 1".
9. Direction of airflow: heaters shall be interchangeable for horizontal left or right or vertical up airflow except when position sensitive mercury contactors or SCRs are built-in. In these cases, airflow direction shall be as scheduled.
10. Safety devices: a disc-type automatic reset thermal cutout shall be furnished for primary overtemperature protection. For secondary protection, a sufficient number of replaceable thermal cutouts in the power lines shall de-energize elements if the primary cutout fails. All safety devices shall be serviceable through the terminal box without removing the heater from the duct.
11. Wiring diagrams: a unique wiring diagram shall be furnished for each heater. Diagram shall include recommended supply wire gauges per NEC and fuse sizes. Typical wiring diagrams are not acceptable.
12. Built-in components shall include safety interlocking disconnect switch, disconnecting break magnetic contactors, transformer with primary fusing per UL, pressure-type airflow switch set at .05" WC, supplementary circuit fuses per NEC (one set of fuses per 48 amp circuit), and separate load and control terminal blocks to accept conductors as shown on the electrical plan.
13. Special features: the following special features are required as scheduled:

## SPECIAL CONSTRUCTION

- Insulated Terminal Box
- Dusttight Terminal Box
- Raintight Construction (nonremovable flange)
- Bottom Insert - open coil only
- Round-duct Construction
- Stainless Steel Frame
- Aluminized Steel Frame
- Protective Screens
  - A. Inlet Side Only
  - B. Outlet Side Only
  - C. Both Sides

## OVERCURRENT PROTECTION

- Automatic Circuit Breakers (in lieu of fuses)
- Fuses Per Step (in lieu of one per 48 amperes)
- Main Supply Overcurrent Protection (heaters 48 amperes or less)

## OVERTEMPERATURE PROTECTION

- Manual Reset Thermal Cutout in control circuit in series with automatic
- Manual Reset Thermal Cutout in power lines (in lieu of secondary cutouts)
- Manual Reset Thermal Cutout operating back-up contactors

## SWITCHING DEVICES AND CONTROLS

- Magnetic Contactors, De-energizing (in lieu of disconnecting)
- Mercury Contactors (sealed for quiet switching)
  - A. Disconnecting Break
  - B. De-energizing Break
- SCRs (solid state modulating control)
- Toggle Switch(es)
  - A. One Per Step
  - B. Interrupts Control Voltage
- Door Interlock Switch (to break control circuit)
- Step Controller(s) (specify input)
  - A. Electronic Modulating
- Time Delay Relay
- PE Switch(es) (for pneumatic control; specify close or open on pressure rise)
- Transducer (pneumatic to 135 Ohm)
- Pilot Light(s)
  - A. One Per Step ( x # of steps)
  - B. Control Voltage On
  - C. Power On (Line Volts)
  - D. Normal Operation (Automatic Reset Circuit is Closed)
  - E. Airflow Switch Open
  - F. Manual Reset Thermal Cutout On
  - G. Push-To-Test Type (Not UL except with 16E)
  - J. Overtemperature (Automatic Reset Cutout Circuit is Open)
  - K. Nema - 12 or Nema - 4
  - L. Heater On

14. Manufacturer to provide two year limited warranty for heating elements; other components and accessories to be warranted for one year.

# Types



Figure 1A Slip-in Heater

**SLIP-IN HEATER**—standard and by far the most widely used because of the ease of installation; see 1A and 1B. When built-in controls are specified in a slip-in heater, they are usually mounted in the left-hand overhang (S dimension in Figure 1B). If right-hand overhang is desired, specify S dimension to be 1", T dimension as required.



Figure 2A Flanged Heater

**FLANGED HEATER**—(optional) consists of a slip-in heater mounted in a flanged duct section; see Figures 2A and 2B. The slip-in portion slides without removing flanges from duct. When built-in controls are specified in a flanged heater, they are mounted in the terminal box of the slip-in portion; the frame containing the elements stays the same. The flanged duct section is increased in depth to accommodate the larger terminal box.

# Dimensions

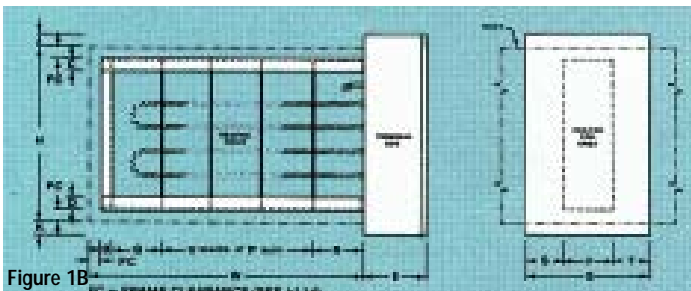

Figure 1B

H = 4" minimum, 180" maximum; W = 5" minimum, 480" maximum (for sizes over H = 90" or W = 120", consult factory). E, F, S, T, Y and G dimensions depend on KW, voltage, phase, number of steps and built-in controls; consult factory.

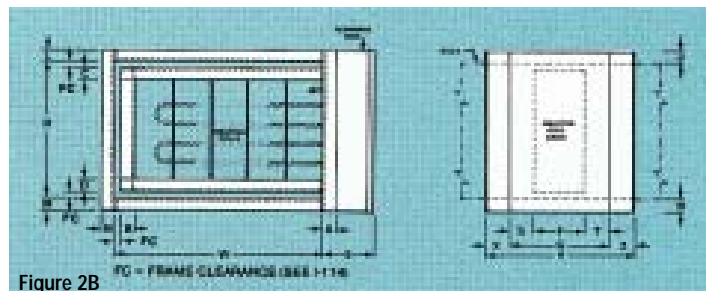

Figure 2B

# Installation

Bulletin I-17 or I-556-1 is included with each heater. Covers maintenance and installation warnings on how NOT to install duct heaters. Service instructions also given.

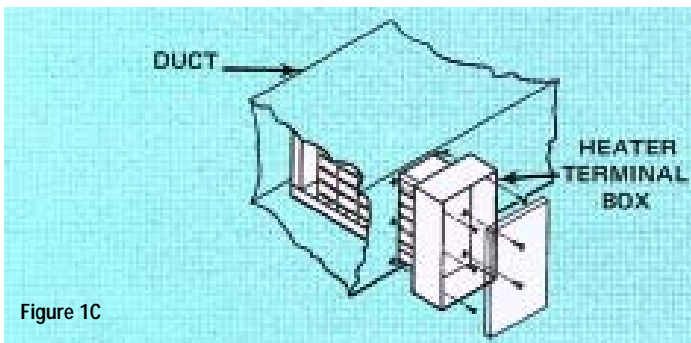

Figure 1C

## Figure 1C SLIP-IN HEATER

- Step 1. Cut hole in side of duct 1/8" larger than heater body.
- Step 2. Insert heater until terminal box covers opening.
- Step 3. Secure heater in place with sheet metal screws.

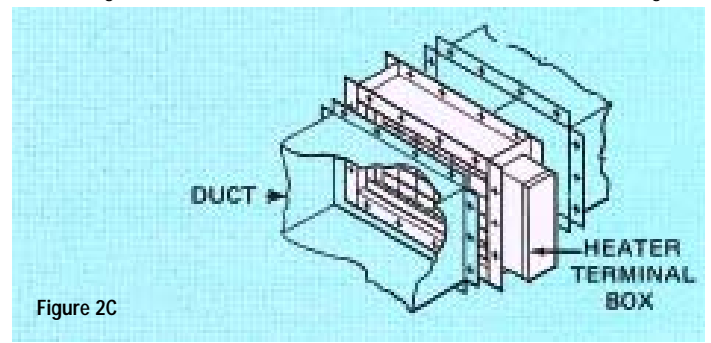

Figure 2C

## Figure 2C FLANGED HEATER

- Step 1. Provide flanges on ends of duct matching heater flanges
- Step 2. Secure heater flanges to duct flanges with sheet metal screws, so that mounting screws do not enter terminal box.

# Construction Details

Automatic reset thermal cutout (primary safety protection) standard on every heater. Automatically resets after heater has cooled. Wired in series with elements on single phase heaters not exceeding the ratings. For all other heaters cutout controls contactors.

Manual reset thermal cutout (optional) secondary safety protection. External reset button is normally located in terminal box cover.

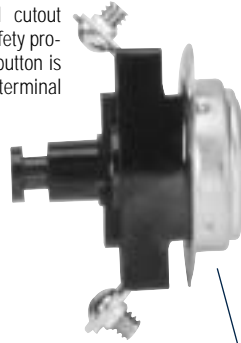
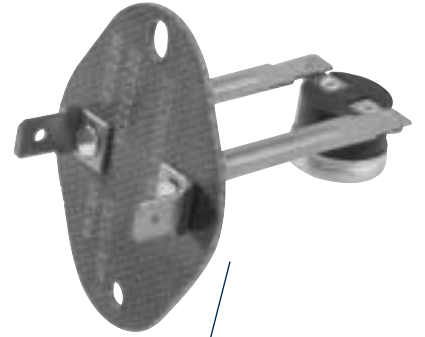

**NOTE:**

Central location of thermal cutout allows same heater to be used for left- or right-hand and vertical up airflow.

Main supply terminals for connection to copper supply wires (standard).

Built-in transformer provides control voltage if not same as line voltage. (Optional)

Properly sized knockouts

Ground lug

Control terminals

Reset button for manual reset thermal cutout. (Optional)

Built-in fuses. (Optional)

Terminal box cover is solid, nonperforated type, assuring dust-free, trouble-free operation of built-in contactors. Screws are accessible from front. Hinged cover provided when fuses, PE switches, or interlocking disconnect switch are built-in. (Cover shown separate here for clarity)

Built-in magnetic contactor. (Optional)

Heavy gauge corrosion protected terminal box (galvanized steel standard)

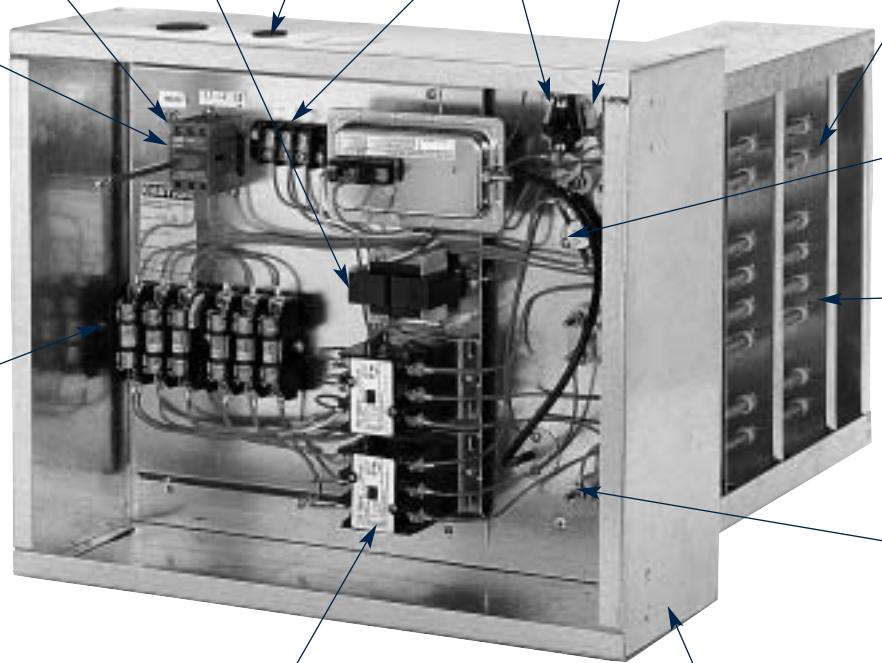

**Figure 1**  
Typical Slip-in Heater (Features also apply to flanged heaters)



Open coil iron-free heating elements. Highest grade (80% nickel, 20% chromium) Type A resistance wire has longer life; coils do not sag or oxidize; resistance does not change with time; glowing is minimized with sufficient airflow. Elements are spread across the face of the heater, when practical, to avoid stratification.

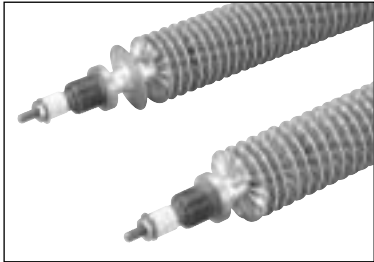
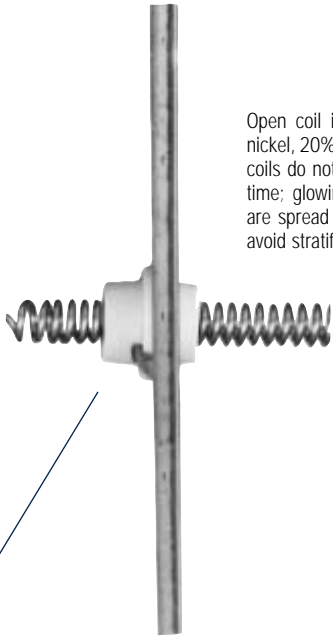

Optional finned tubular heating elements. 80/20 nickel/chromium inner coil centered in copper-plated steel tubes; magnesium oxide filler assures rapid heat transfer from coil to steel fins brazed to tube; silicone rubber double seals prevent magnesium oxide contamination. High temperature aluminum coating protects element surfaces from corrosion.



Secondary disc-type cutouts standard on every heater. Set at higher temperature than automatic reset thermal cutout. Meets UL and NEC requirements. Sufficient number of cutouts located in the power lines de-energize elements should automatic reset thermal cutout fail; easily serviced through the terminal box. No back-up contactors are required.

Support brackets with special reinforcements (ribbing along edges and gussets in top and bottom mounting flanges)

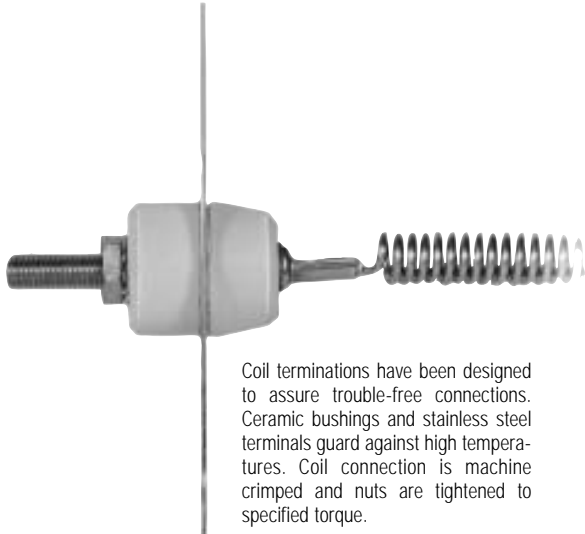

Coil terminations have been designed to assure trouble-free connections. Ceramic bushings and stainless steel terminals guard against high temperatures. Coil connection is machine crimped and nuts are tightened to specified torque.

# Step Controllers

Step controllers are used to control multi-step heaters.

## ELECTRONIC MODULATING

Solid state electronic step controllers will switch up to ten contactor holding coils each and may be wired in series for a maximum of 30 steps. They are available with a single input from all commonly used thermostat input signals. The step controller automatically recycles to the full-off position in case of a power interruption.

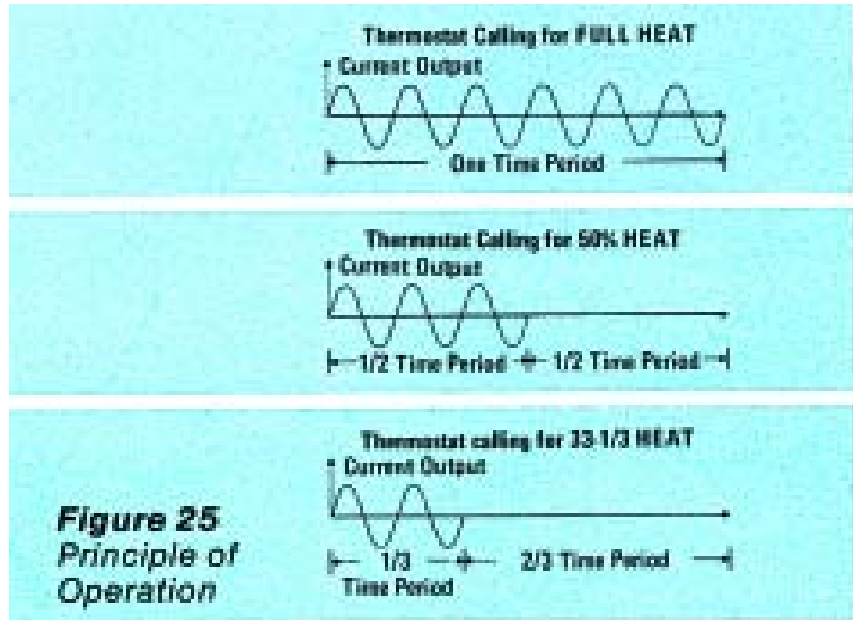

# SCRs

Silicone controlled rectifiers (SCRs) are used to provide very close heat control and/or silent operation for critical areas such as laboratories, computer rooms and executive offices. They are a solid state device with no moving parts which will provide 100% stepless and noiseless modulation through many years of trouble free service. The SCR has heat sink mounted protruding through the terminal box to maximize convection cooling. The heat sink is electrically insulated from live parts. Power and heat output are precisely controlled from zero to 100% in direct response to the modulating thermostat signal (figure 25). All commonly used thermostat input signals will be accepted by the SCR without a special interface. A safety contactor must be used.

All elements in the heater are simultaneously controlled, thus avoiding problems of air stratification. Zero angle firing interrupts the full wave AC cycle only when current passes through zero, minimizing radio frequency interference.

# SCR Vernier

SCR Vernier systems are used on larger KW heaters where very close heat control is required. The SCR Vernier system employs a combination of SCR and non-SCR steps. For electric/electronic controls, a step controller energizes the non-SCR steps; for pneumatic controls, adjustable differential PE switches energize the non-SCR steps. The system is more economical for larger KW heaters than full SCR control while providing the same very close heat control as the full SCR system. This is accomplished by satisfying most of the heat requirement through the non-SCR steps and then the last portion of the heat requirement is "fine-tuned" by the modulating SCR controller. The SCR step is nominally equal to the KW of a non-SCR step to provide an even transition between steps.



# Thermostats

Table 23: Thermostats

| Catalog Number | Type             | Temp. Range | Ratings               | Action          | No. Steps |
|----------------|------------------|-------------|-----------------------|-----------------|-----------|
| T-101          | Room             | 40 - 90° F  | 120 - 240V            | Pilot           | 1         |
| T-102          | Room             | 40 - 90° F  | 120 - 240V            | Pilot           | 2         |
| T-111          | Room             | 40 - 90° F  | 24V                   | Pilot           | 1         |
| T-112          | Room             | 40 - 90° F  | 24V                   | Pilot           | 2         |
| T-201          | Room             | 40 - 90° F  | 120 - 277V            | Line            | 1         |
| T-300          | Room             | 60 - 90° F  | D.C./Resistive Output | Step Controller | Mod.      |
| C1025          | Room             | 60 - 90° F  | D.C./Resistive Output | SCR             | Mod.      |
| T-400          | Room             | 40 - 90° F  | Pneumatic             | Direct Acting   | Mod.      |
| T-401          | Room             | 40 - 90° F  | Pneumatic             | Reverse Acting  | Mod.      |
| T-601          | Duct             | 60 - 90° F  | 120 - 240V            | Pilot           | 1         |
| T-602          | Duct             | 60 - 90° F  | 24 - 240V             | Pilot           | 2         |
| T-603          | Duct             | 60 - 90° F  | 24 - 277V             | Pilot           | 3         |
| T-604          | Duct             | 60 - 90° F  | 120 - 277V            | Pilot           | 4         |
| T-810          | Duct             | 80 - 100°F  | D.C./Resistive Output | Step Controller | Mod.      |
| T-100-M043     | Duct             | 0 - 180°F   | D.C./Resistive Output | SCR             | Mod.      |
| TG-100M        | Thermostat Guard | —           | —                     | —               | —         |

**NOTE:** Data subject to change without notice.

# Special Constructions

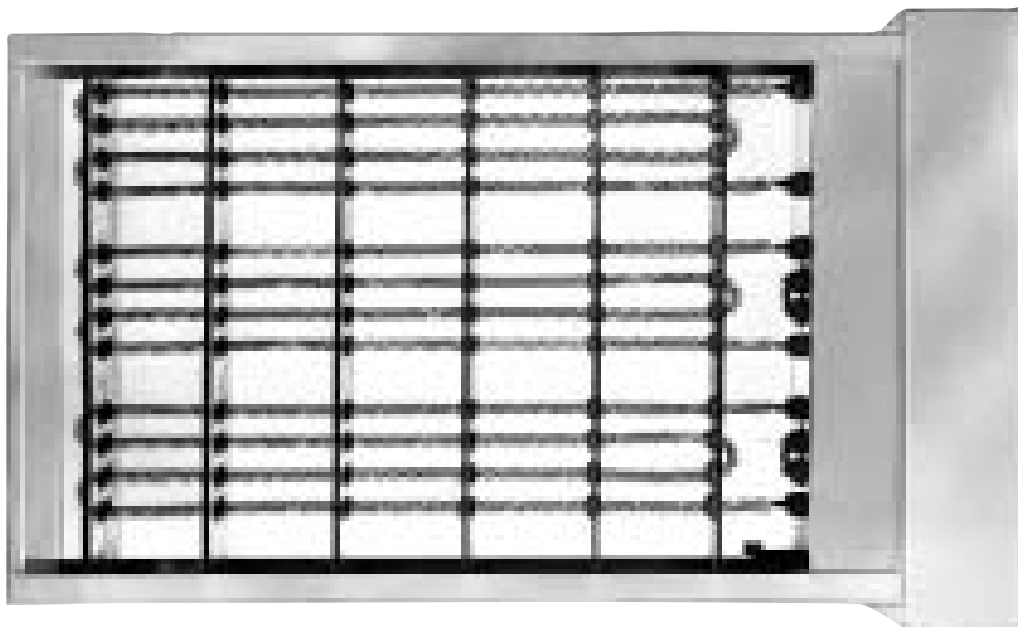

Heaters for  
Ducts with  
Internal  
Obstructions

**RECESSED TERMINAL BOX**—for slip-in heaters; brings element terminals and thermal cutouts further into the airstream (recommended where the element terminals are blocked by an obstruction of more than 1").



**DUSTTIGHT TERMINAL BOX**—slip-in or flanged heaters have sturdy terminal box and cover with sealed seams. A gasket is provided inside the terminal box cover to seal the cover to the terminal box. UL Listed for indoor use only.

## Bottom Terminal Boxes

**BOTTOM INSERT**—slip-in heater inserts through a hole in the bottom of a horizontal duct. Internal terminal box contains resistance coil terminations, automatic reset and secondary thermal cutouts, all prewired to terminal blocks in field terminal box. Control components such as contactors, fuses and transformers are mounted in bottom terminal box. Specify W and H dimensions (minimum W dimension is 12").

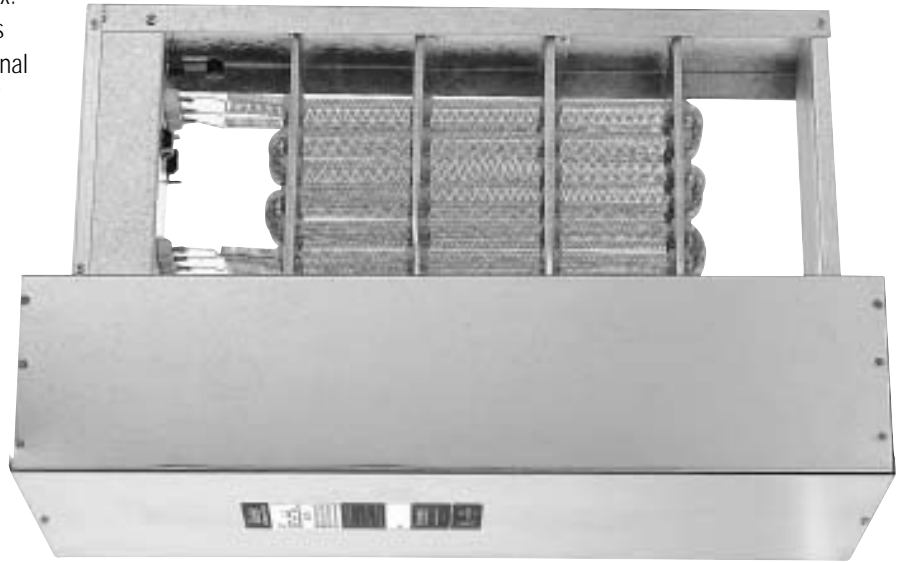

**RAINTIGHT HEATER**—UL Listed for outdoor use; formed of heavy gauge galvanized steel, sealed with high temperature sealant. May be supplied with recessed construction. Flanged construction fits any horizontal, rectangular duct. Available with standard built-in components that do not protrude through door such as contactors, fuses, transformers, step controller, PE switches, etc. Insulated terminal box or insulated flange are not available UL Listed. Consult local representative for additional information. Not suitable for use in salt spray environments.

## Special Constructions (cont.)

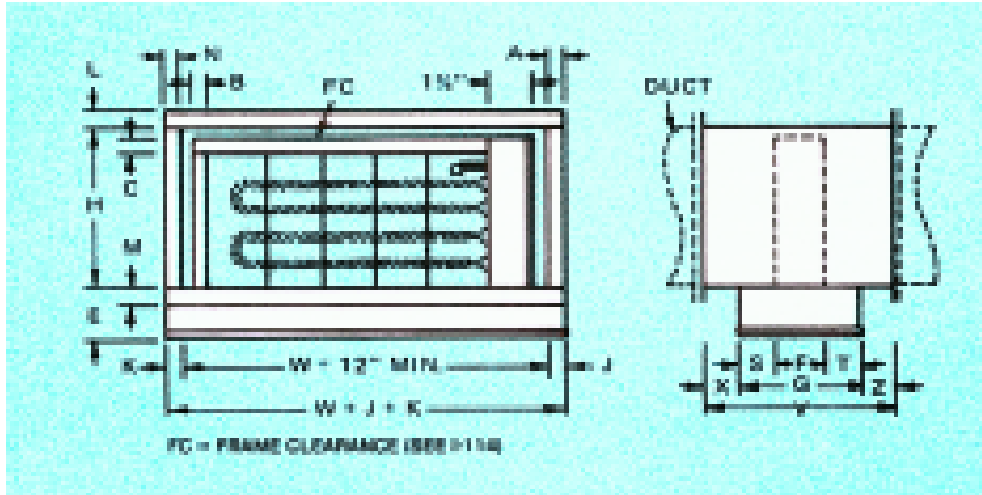

**BOTTOM OUTLET**—recommended where a flanged heater is desired with field terminal box at the bottom of the horizontal duct. Internal terminal box contains resistance coil terminations, automatic reset thermal cutout and secondary thermal cutouts, all prewired to terminal blocks in field terminal box. Control components such as contactors, fuses and transformers are mounted in bottom terminal box. Not available with built-in weather resistant or dusttight terminal box.

**INSULATED TERMINAL BOX**—recommended whenever heaters are used in air conditioning ducts in areas with high relative humidity. Slip-in or flanged heaters with insulated terminal box have insulating board fastened to the back of the terminal box, between the duct and the terminal box.

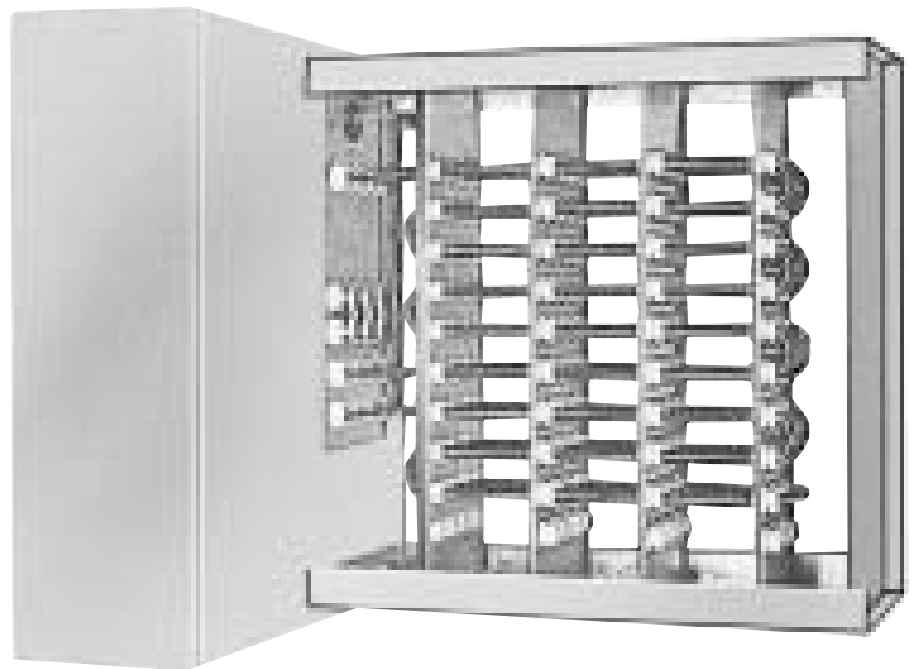

**PROTECTIVE SCREENS**—prevent accidental contact and possible electrical shock, especially where maintenance personnel are likely to enter the duct near the heater. Galvanized 1/2" x 1/2" hardware cloth mesh is standard. Screen also prevents debris such as loose duct insulation, etc. from contacting heater coils.

When ordering, specify:

- A. Inlet Side Only
- B. Outlet Side Only
- C. Both Sides

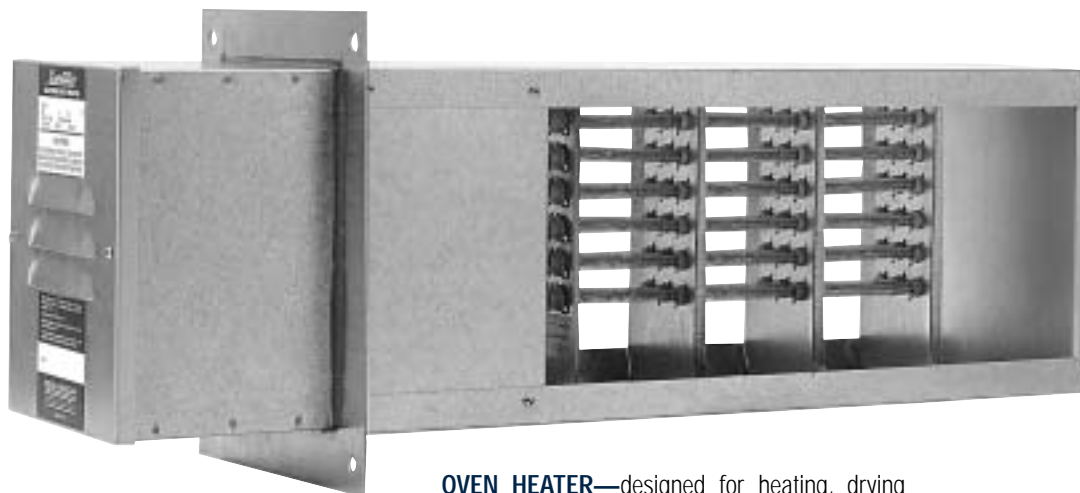
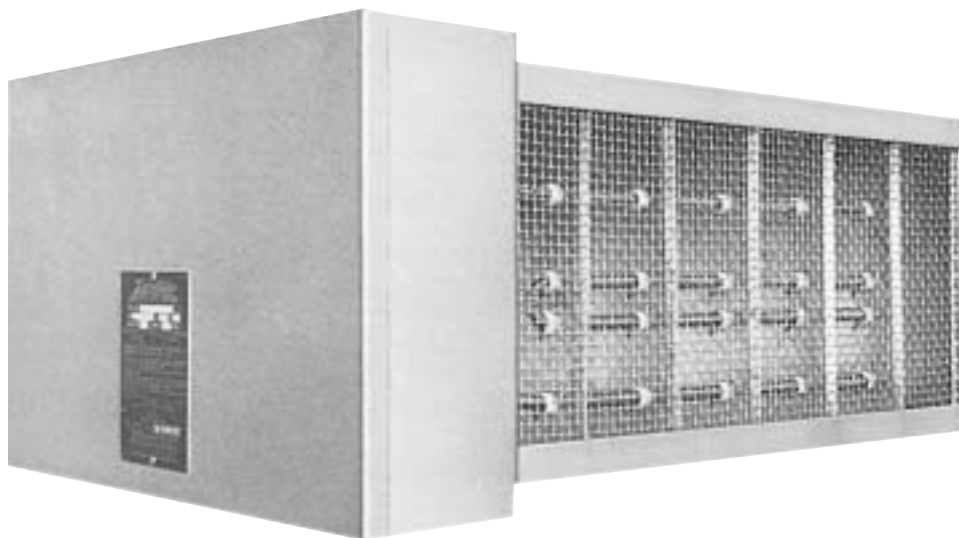

**OVEN HEATER**—designed for heating, drying and baking applications in industrial ovens. Air temperatures to 1200° F are maintained by forced air circulation. Highest Grade Type A (80/20) resistance wire elements minimize oxidation. Elements are derated on an increasing scale to match design temperature conditions. Frames are of galvanized, aluminized, or stainless steel, depending on outlet temperature. Optional features include control thermostat, high limit cutout, airflow switch, remote panel with built-in components. UL or not UL Listed.

## Special Constructions (cont.)

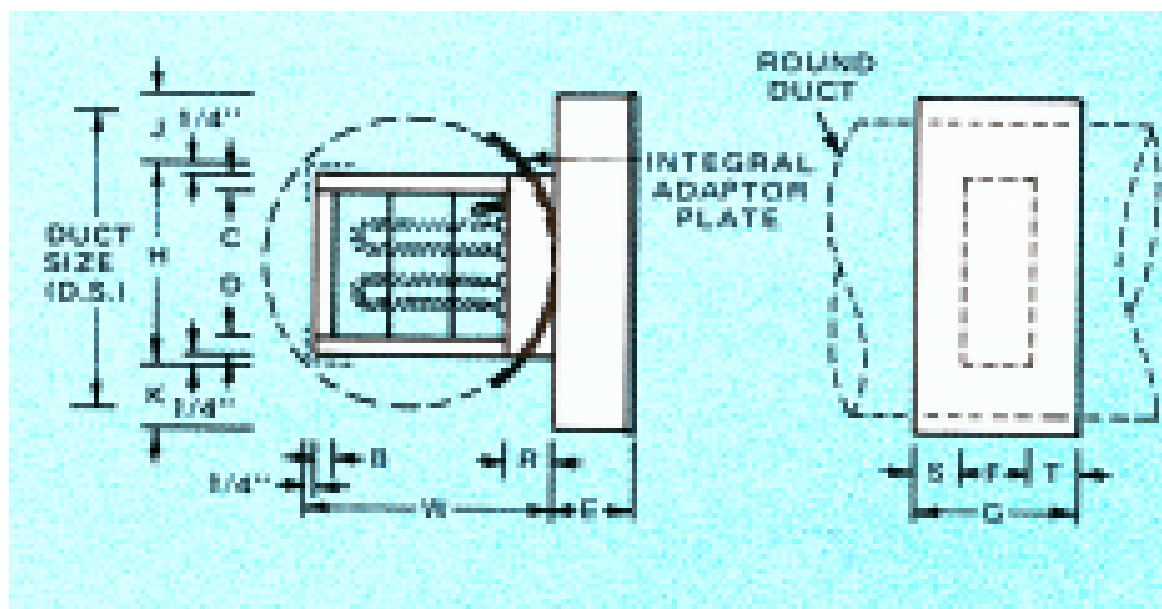

**ROUND-DUCT**—UL Listed, designed for insertion into round ductwork. Basic slip-in style with special adapter plate to fit specified duct diameter.

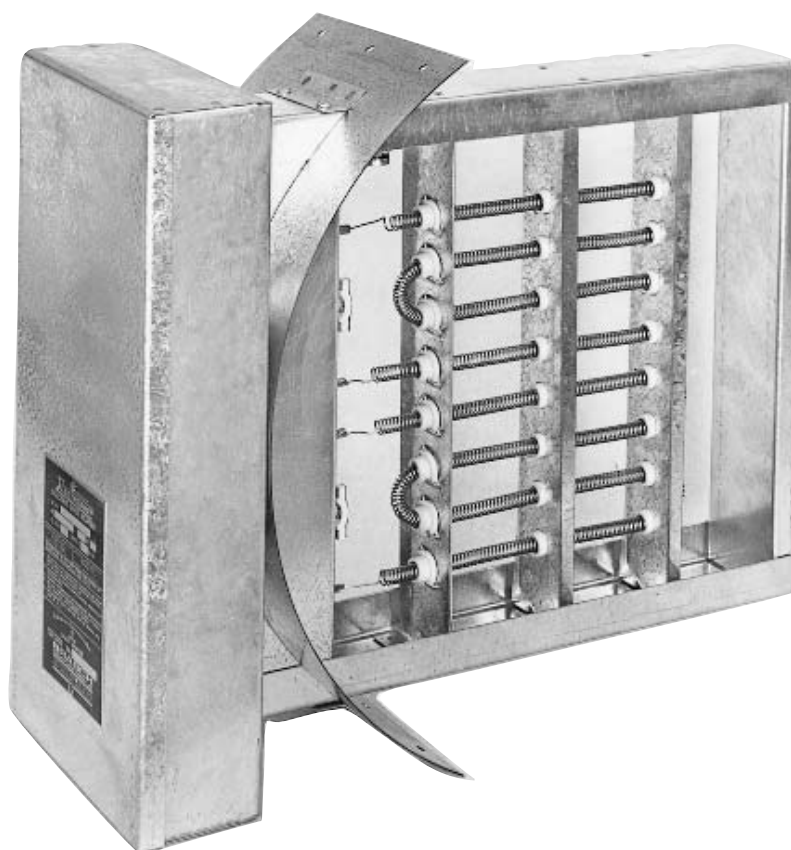



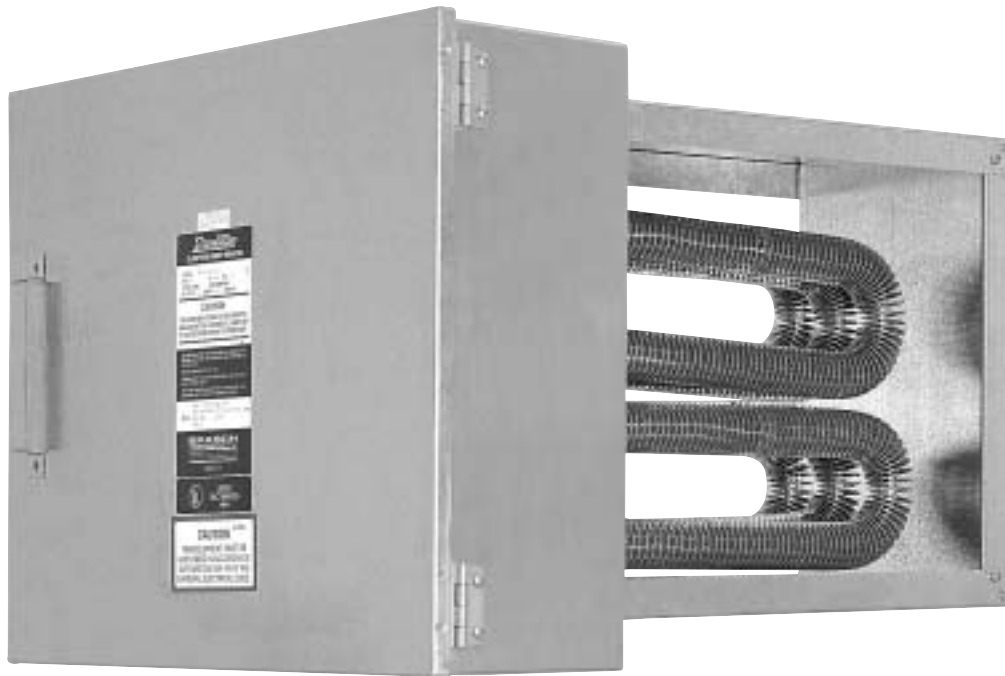

## Finned Tubular

**SLIP-IN AND FLANGED**—UL Listed, heavy gauge galvanized steel frame (aluminized and stainless optional); solid cover; nonperforated terminal box (dust-tight NEMA 12 optional); properly sized knockouts; interchangeable airflow, horizontal in either direction or vertical up. Finned elements use 80/20 nickel/chromium resistance wire, helically wound and centered in a copper plated steel tube filled and compacted with magnesium oxide for rapid heat transfer; silicone rubber double seals prevent contamination. High temperature aluminum coating further protects element from corrosion. Also available in frit (glass-ceramic) coated.

**FLANGED HEATER (Non-Removable Heater Section)**—UL Listed units are designed for horizontal or vertical rectangular ducts. Units are of heavy gauge galvanized steel (standard) or aluminized steel (optional). Terminal box for control components is built in. For flanged heater with removable heater section see page 5.

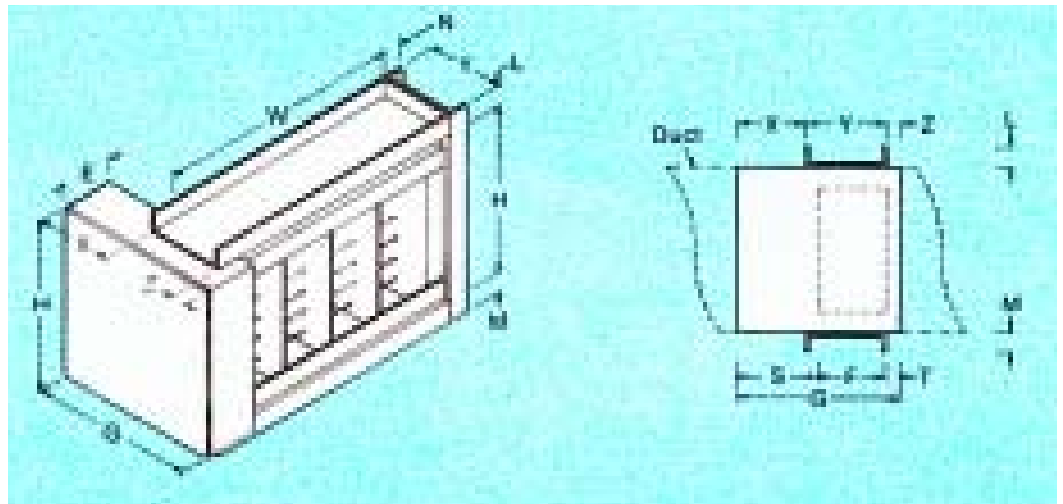

# Technical Data

**MULTIZONE APPLICATIONS**—where electric heaters are installed in air handling equipment with multizone dampers which constantly reposition, depending on the requirements of each zone, special precautions must be taken in the design of the heaters.

Both slip-in and flanged heaters are suitable for multizone equipment, depending upon the configuration of the unit. The frame dimensions must be carefully chosen so the heater will fit the multizone unit. We recommend the dimensions be approved by the multizone unit manufacturer. Care must be taken so that no part of the heater face area is blocked by the frame members, cooling coil headers, filter supports or blower housings. Multizone heaters should be ordered with no coils three to four inches from the top, bottom or back flanges because these areas are exposed to reduced airflow conditions. If necessary, a recessed terminal box can be used to extend element terminals into the airstream, past any obstructions. Multizone heaters must be significantly derated in terms of watt density per square inch of heating element surface; 25 watts maximum per square inch of element is recommended.

A special linear cutout must be ordered in addition to standard primary and secondary thermal cutouts. The linear cutout deenergizes the entire heater in the event of a temporary high temperature condition along any 12" section. It will automatically reset itself and the heater will resume normal function when the hot spot has cooled.

Built-in components are not recommended for multi-zone applications. Instead, a remote control panel is recommended.

**HOT DECK CONTROL SYSTEMS**—in addition to derating the coils and providing the heater with a linear type cutout, an averaging-type thermostat extending the entire length of the hot deck is necessary to modulate the amount of heat supplied in accordance with the actual total load requirement. For smaller loads, SCRs are recommended to control the entire heater, or a step controller can be used, as long as the number of

steps is equal to at least the number of zones plus one. For larger loads, a combination step controller/SCR Vernier system is recommended. This system combines the advantage of almost infinite modulation offered by SCRs with the economy of the step controller. Combination step control/SCR Vernier systems are described in detail on page 8.

**SINGLE ZONE AIR HANDLING UNITS**—electric heaters can be used in place of hot water or steam coils in air handling units. Slip-in or flanged construction can be used, depending upon which is most suitable for the particular application. If a flanged heater is desired, but the maximum thickness of the heater is limited, a modified flange design can be used. Heater dimensions and construction should be carefully coordinated with the air handling unit manufacturer. Follow these guidelines:

1. Because airflow is not always uniform in an air handling unit, the watt density of the resistance wire should be reduced to a maximum of 35 watts per square inch of wire surface.
2. If face and bypass damper are used, watt density should be reduced to a maximum of 25 watts per square inch of wire surface. Heater must be interlocked with the face damper to prevent operation until damper is open.
3. If the face area directly adjacent to the terminal box will be blocked by a cooling coil header, baffles or frame members, a recessed terminal box is recommended. Amount of recess must be sufficient to clear obstructions.
4. All heaters for use with air handling equipment should be ordered with no heating elements three to four inches from the top, bottom and back flange. These areas often receive little or no airflow.

Use these formulae as rough guidelines for estimating purposes only:

### Formula #1

$$KW^* = \frac{CFM \times \Delta T}{3160}$$

### Formula #2

$$\Delta T = \frac{KW \times 3160}{CFM}$$

\*Approximate - formulas are based on 70° F entering air and actual KWs will vary with a change of inlet temperature.

**TOTAL KW REQUIRED**—use Formula #1 to figure total KW needed when air volume and temperature ( $\Delta T$ ) are known:

**NUMBER OF STEPS**—for the average installation it is customary to figure the temperature rise ( $\Delta T$ ) provided by each heating step as follows:

Using Formula #1, figure KW per step when temperature rise and CFM are known. When the KW per step is known, use Formula #2 as a rule of thumb to figure the temperature rise per step.

For economy, we recommend each step be limited to a maximum of 48 amperes. See page 11 for KW ratings equivalent to 48 amperes.

For practical design of heater, minimum recommended KW per step is .5 KW for 208V single phase; 1.0 KW for 277V or 480V single phase and 2.0 KW for 480V or 600V three phase.

Minimum number of steps for multizone heaters should be equal to number of zones plus one.

| COMFORT HEAT CONTROL DESIRED | $\Delta T$ PER STEP |
|------------------------------|---------------------|
| Very Fine Control            | 5° or less          |
| Average Control              | 6 to 14° F          |
| Coarse Control               | 15° F and up        |

## Minimum Air Velocity Open Coil Elements

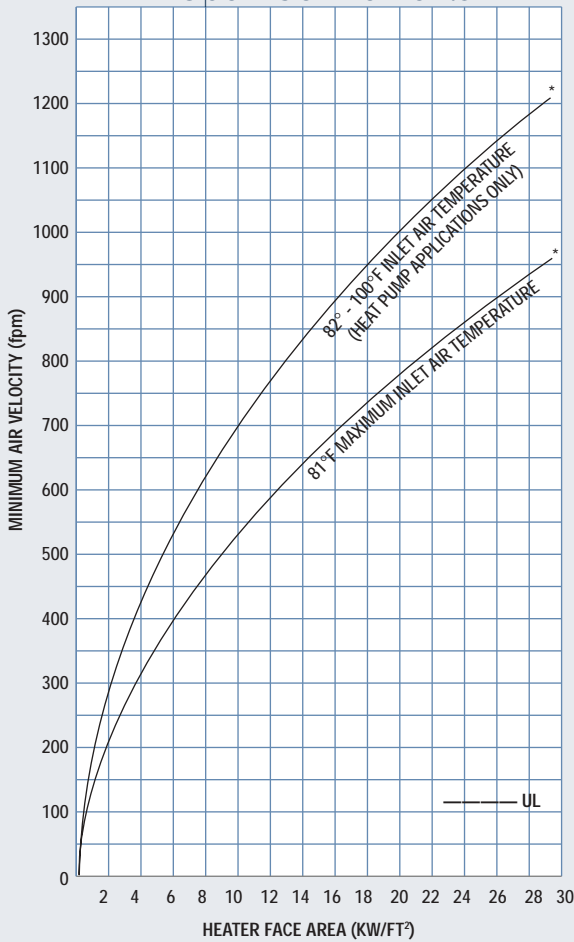

\*Maximum allowed watt density: 28.9 KW/FT²

$$\text{Face Area} = \frac{(H-2\frac{1}{2}" ) (W-3\frac{1}{4}" )}{144}$$

$$\text{KW/FT}^2 = \frac{\text{KW}}{\text{Face Area}}$$

## Minimum Air Velocity Finned Tubular Elements

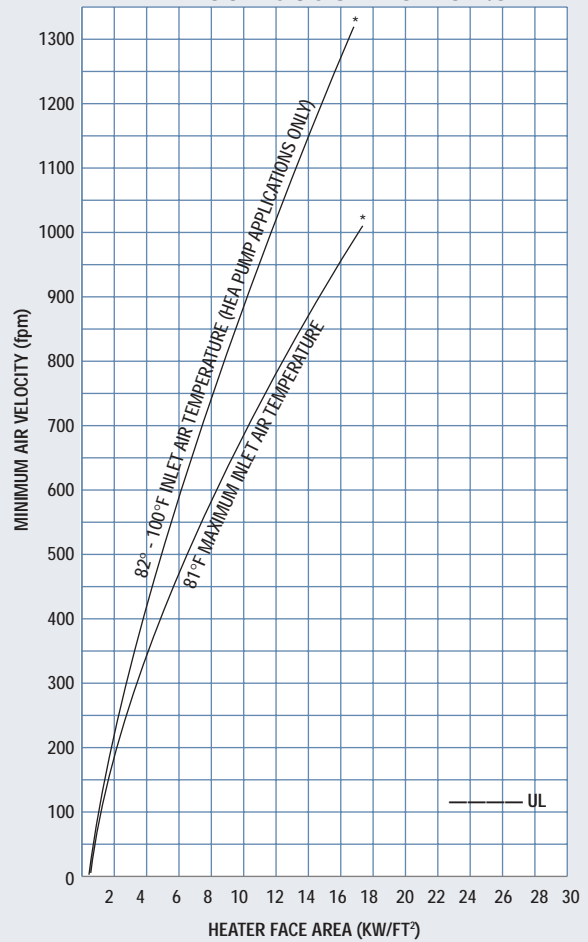

\*Maximum allowed watt density: 17.0 KW/FT²

Example: 25 KW UL Heater, Inlet 75° F  
12" H x 24" W, Open Coil Elements

$$\text{Face Area} = \frac{(12-2\frac{1}{2}" ) (24-3\frac{1}{4}" )}{144} = 1.53 \text{ Ft}^2$$

$$\text{KW/FT}^2 = \frac{25}{1.53} = 16.3$$

$$16.3 \text{ KW/FT}^2 = 700 \text{ fpm}$$

## Pressure Drop Through Heater (inches water)\*

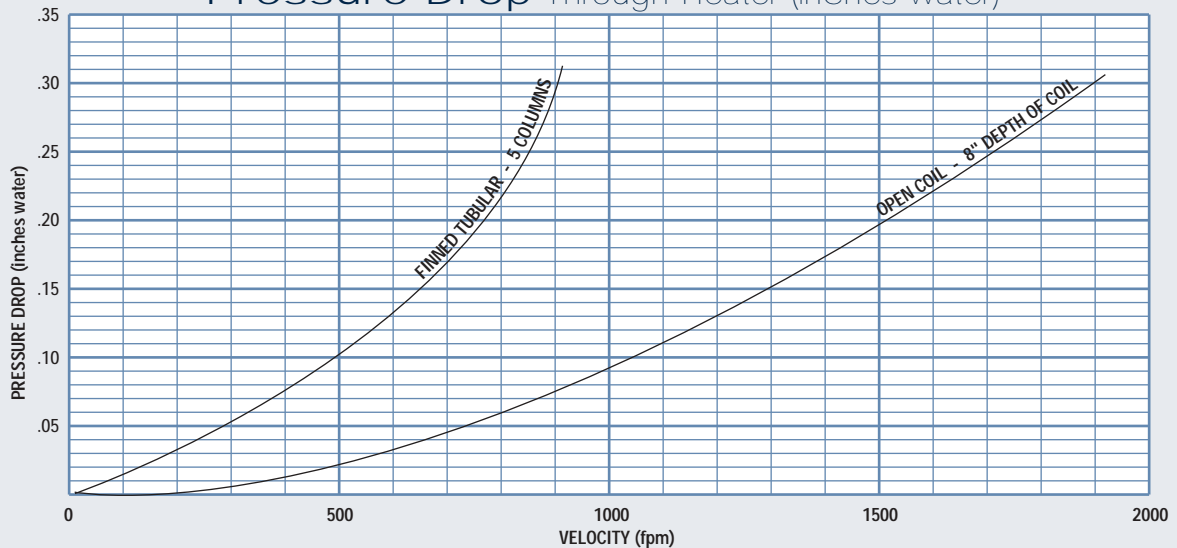

\*This is an estimate only and will vary with the specific construction of each heater. Calculations for specific heaters can be run on a computer program but are still rough approximations. Actual pressure drops can only be found by performing pressure drop tests on the actual duct heater after manufacture.

# How to Calculate Line Currents

To determine the line current use the following formulae

## Single Phase

$$\text{LINE CURRENT } (I_L) \text{ in amperes} = \frac{\text{WATTAGE}}{\text{VOLTAGE}}$$

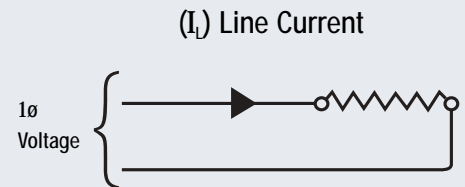

## Three Phase

$$\text{LINE CURRENT } (I_L) \text{ in amperes} = \frac{\text{WATTAGE}}{\text{VOLTAGE} \times 1.73}$$

NOTE: This is the current which will flow in each of the three lines, regardless of whether the elements are wye or delta connected.



**SUPPLY WIRE AND LINE TERMINALS SIZING**—UL requires that the line terminals in duct heaters be sized to accept conductors which are rated to carry at least 125% of heater line current. Heaters are provided with properly sized terminals at no extra charge. Field supply wires must be sized to carry at least 125% of heater line current except when the heater is for space heating, is over 50KW and not more than 3 wires in the conduit—may be sized at 100% of heater line current. Supply conductors must have insulation rated at least 75° C (167° F).

# Wiring Diagram Control System 1

Single or multi-step heater with de-energizing magnetic contactors per step, fusing per NEC and 24 volt transformer. Can be controlled by a single/multiple stage room or duct thermostat, remote step controller and modulating room or duct thermostat or signal from various electronic building system controls. Standard options available include disconnecting magnetic contactors, interlocking disconnect switch and remote control panel. For other options, consult factory or the local Brasch representative.

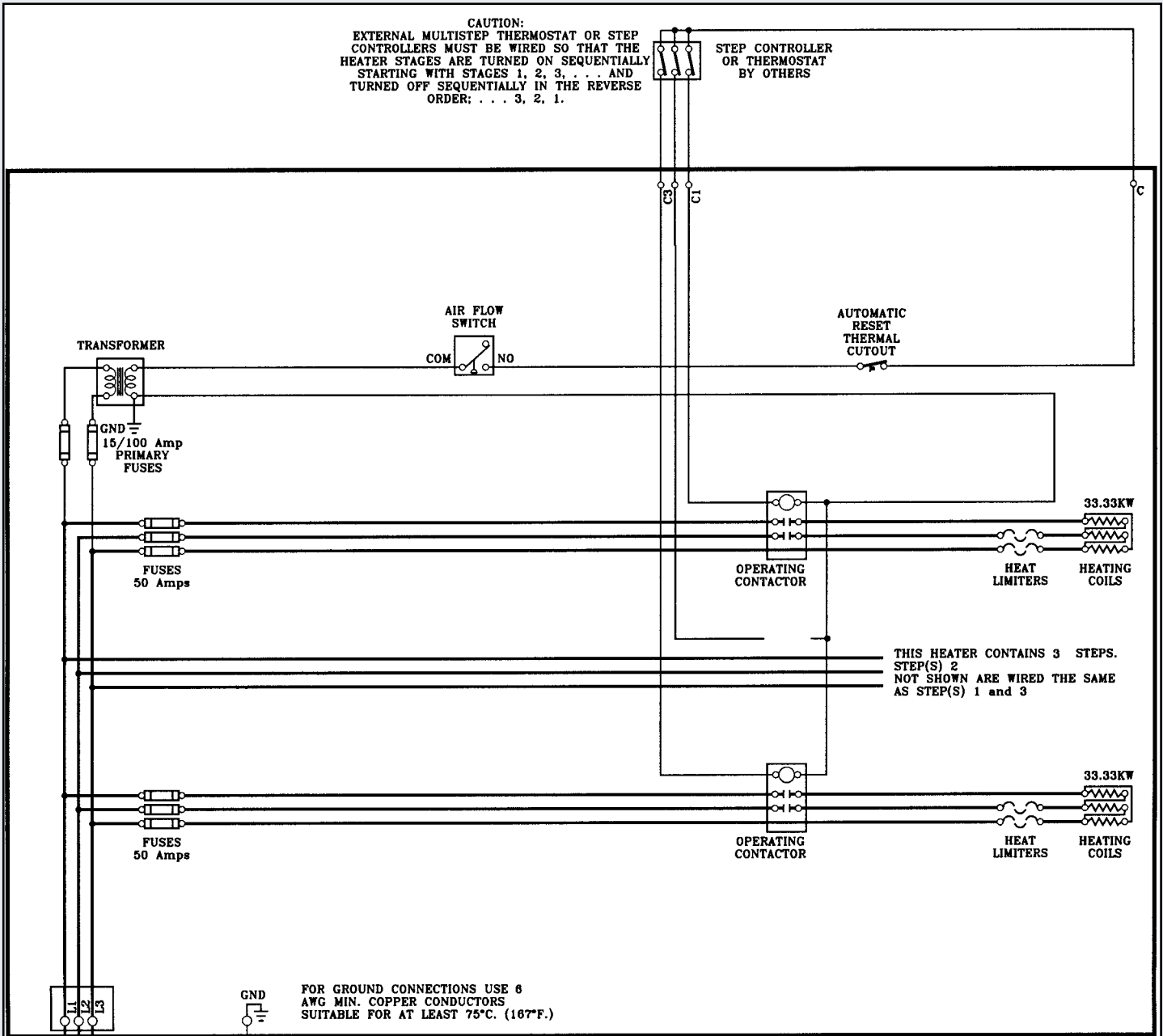

DISCONNECTING MEANS AND OVERCURRENT PROTECTION BY OTHERS (IF REQUIRED)

POWER:(FACTORY WIRED) \_\_\_\_\_  
 POWER:(FIELD WIRED) \_\_\_\_\_  
 CONTROL:(FACTORY WIRED) \_\_\_\_\_  
 CONTROL:(FIELD WIRED) \_\_\_\_\_

**HEATER**

1. FOR SUPPLY CONNECTIONS USE MIN. 1 AWG COPPER CONDUCTORS SUITABLE FOR AT LEAST 75°C. (187°F.)
2. FIELD TERMINALS SUITABLE FOR USE WITH 1x300 MCM COPPER CONDUCTORS ONLY.
3. WIRE GAUGES ARE BASED ON NOT MORE THAN 3 WIRES IN A SINGLE CONDUIT.
4. THIS HEATER REQUIRES 1 SUPPLY CIRCUIT(S) OF 100.00 KW.
5. SUPPLY VOLTAGE 480 PHASE 3 CONTROL VOLTAGE 24 PHASE 1
6. CONTROL CIRCUIT WIRING TO BE NEC CLASS 1.

**BRASCH**  
 MANUFACTURING COMPANY, INC.

11880 DORSETT ROAD . (314) 291-0440  
 MARYLAND HEIGHTS, MISSOURI 63043

DATE: 06/13/2001

TAG:

HEATER CATALOG NUMBER:  
 1997-0002197



# Wiring Diagram Control System 2

Multi-step heater with de-energizing magnetic contactors per step, built-in step controller, fusing per NEC and 120 volt transformer with primary fusing. Can be controlled by a modulating room or duct thermostat or signal from various electronic building system controls. Standard options available include disconnecting magnetic contactors, interlocking disconnect switch and remote control panel. For other options, consult factory or the local Brasch representative.

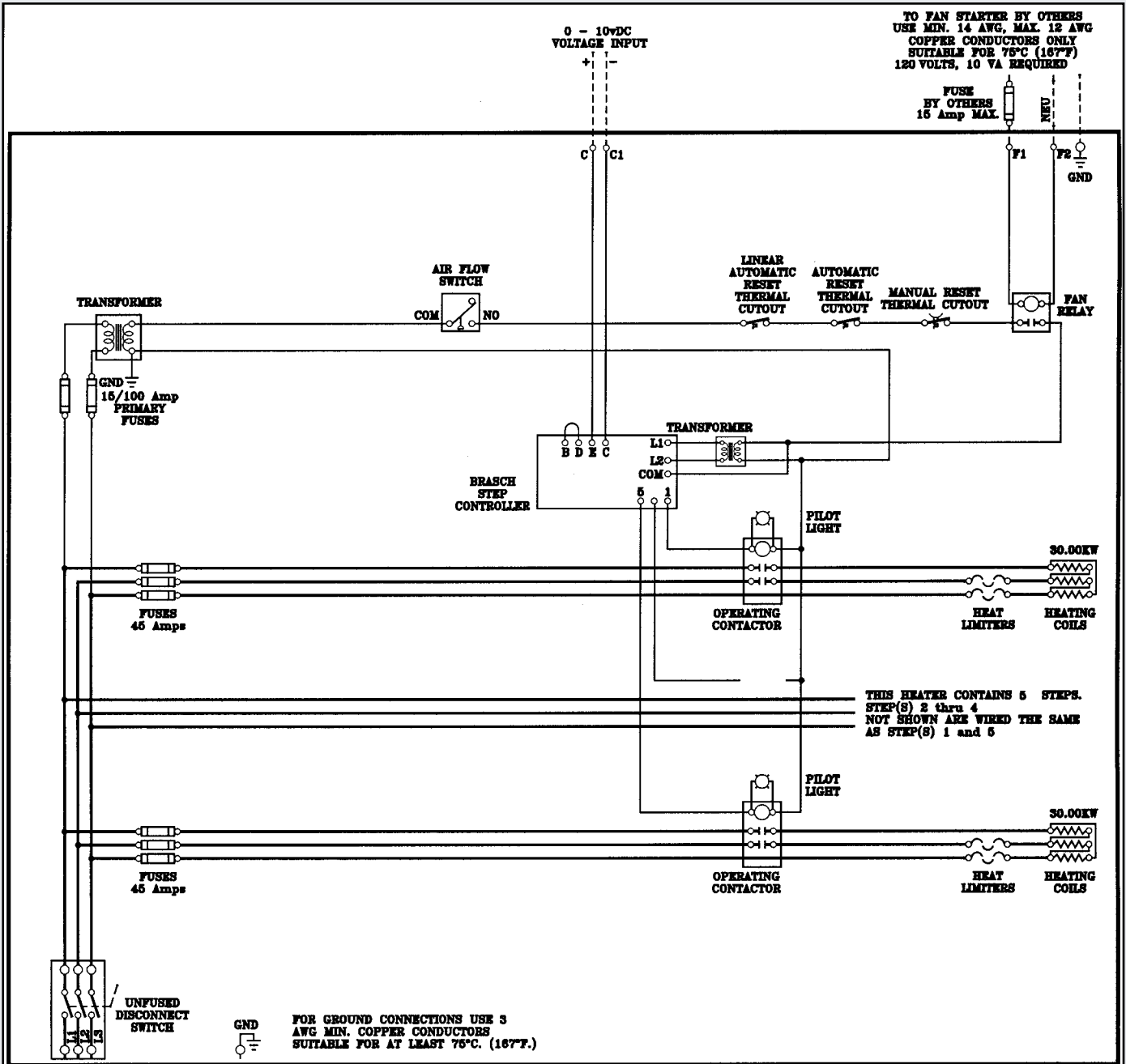

ELECTRODUCT HEATER

DISCONNECTING MEANS AND OVERCURRENT PROTECTION BY OTHERS (IF REQUIRED)

POWER:(FACTORY WIRED) \_\_\_\_\_  
 POWER:(FIELD WIRED) - - - - -  
 CONTROL:(FACTORY WIRED) \_\_\_\_\_  
 CONTROL:(FIELD WIRED) - - - - -

- HEATER
1. FOR SUPPLY CONNECTIONS USE MIN. 3/0 AWG COPPER CONDUCTORS SUITABLE FOR AT LEAST 75°C. (167°F.)
  2. FIELD TERMINALS SUITABLE FOR USE WITH 1x300 MCM COPPER CONDUCTORS ONLY.
  3. WIRE GAUGES ARE BASED ON NOT MORE THAN 3 WIRES IN A SINGLE CONDUIT.
  4. THIS HEATER REQUIRES 1 SUPPLY CIRCUIT(S) OF 150.00 KW.
  5. SUPPLY VOLTAGE 480 PHASE 3 CONTROL VOLTAGE 24 PHASE 1
  6. CONTROL CIRCUIT WIRING TO BE NEC CLASS 1.

**BRASCH**

MANUFACTURING COMPANY, INC.  
 11880 DORSETT ROAD . (314) 291-0440  
 MARYLAND HEIGHTS, MISSOURI 63043

DATE: 06/13/2001

TAG:

HEATER CATALOG NUMBER:  
 2000-0009998

# Wiring Diagram Control System 3

Multi-step heater with SCR Vernier control. Step 1 is SCR and is equal to each step on the step controller. Controls include SCR's, step controller, de-energizing magnetic operating contactors per step and safety contactor, fuses per NEC, and 120 volt transformer with primary fusing. Can be controlled by a modulating room or duct thermostat or signal from various electronic building system controls. Standard options available include disconnecting magnetic contactors, interlocking disconnect switch and remote control panel. For other options, consult factory or the local Brasch representative

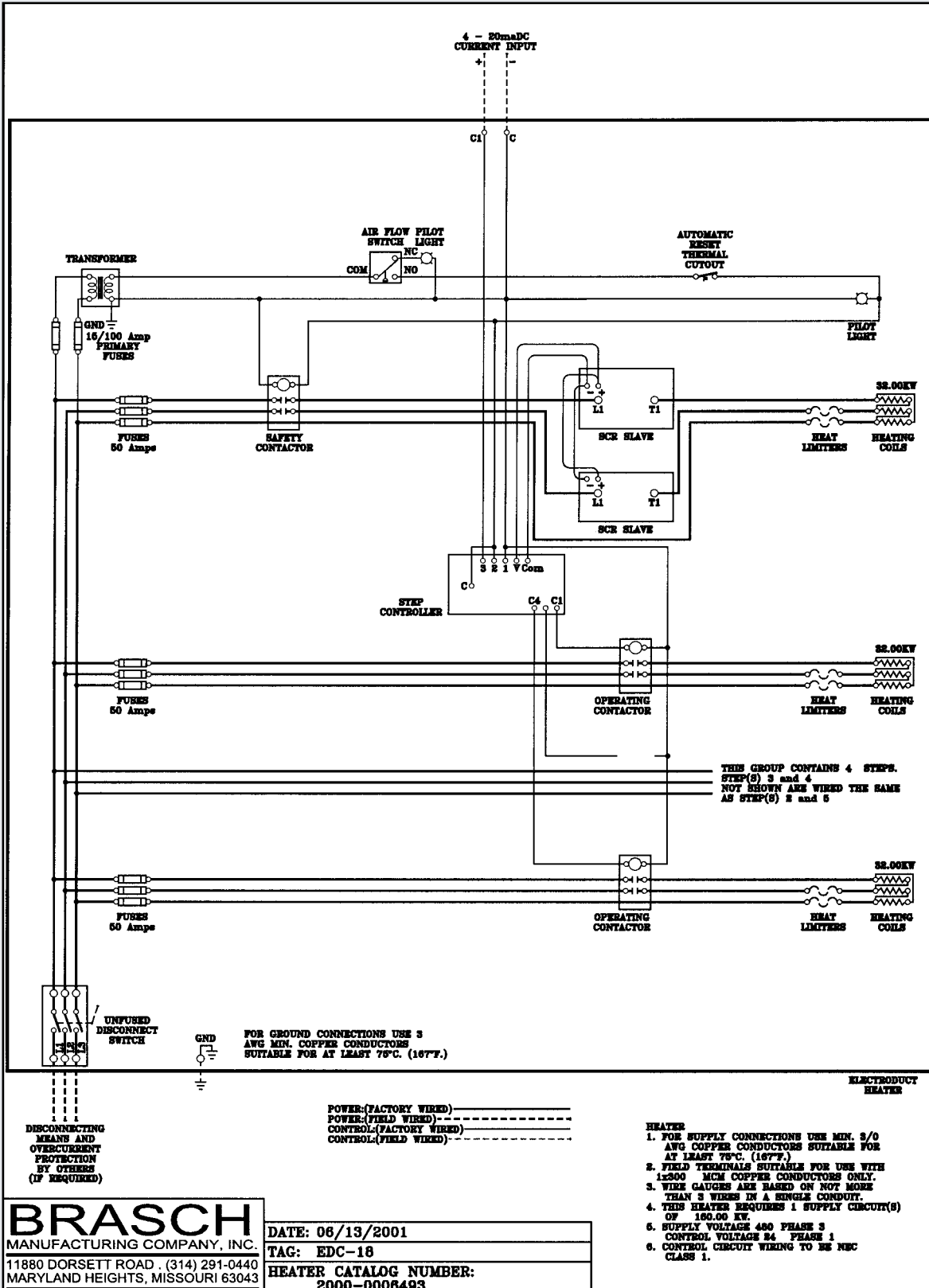

# Wiring Diagram Control System 4

Total SCR controlled heater with SCR's, de-energizing magnetic safety contactors per step and safety contactor, fuses per NEC, and 24 volt transformer. (Above approximately 100 amps total heater load, the economics of System 3 should be considered). Can be controlled by a modulating room or duct thermostat or signal from various electronic building system controls. Standard options available include disconnecting magnetic contactors, interlocking disconnect switch and remote control panel. For other options, consult factory or the local Brasch representative.

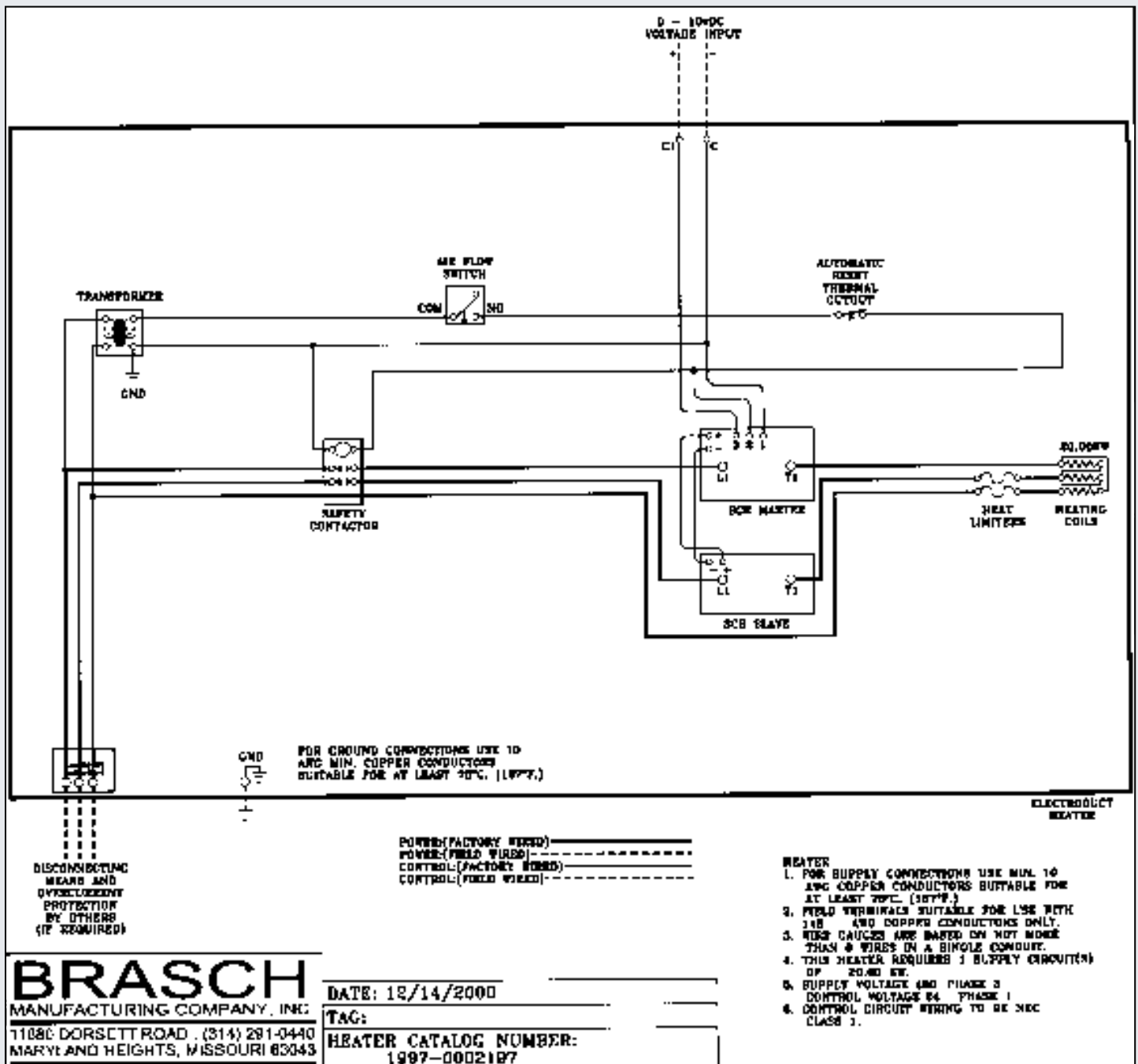

# UL/NEC Requirements\*

## REQUIREMENT

### DOUBLE SAFETY PROTECTION

UL 1996, Paragraph 23.3.1:

"A duct heater shall be equipped with one or more automatically resetting temperature-limiting controls, as determined by 23.3.3, that will disconnect the heating element or elements from the supply circuit to prevent temperatures from exceeding the limits specified. These temperature-limiting controls shall be factory-installed as an integral part of the heater."

NEC Article 424-64:

"Limit Controls. Each duct heater shall be provided with an approved, integral, automatic-reset temperature-limiting control or controllers to de-energize the circuit or circuits."

### Secondary Control

NEC Article 424-64 (continued):

"In addition, an integral independent supplementary control or controllers shall be provided in each duct heater that will disconnect a sufficient number of conductors to interrupt current flow. This device shall be manually resettable or replaceable."

UL 1996, Paragraph 23.3.9:

A duct heater shall be provided with one or more manually resettable or replaceable back-up protective devices of the type specified in 23.3.7, that will, with the contacts of the automatically reset limit control permanently closed, limit the temperature to comply with the requirements specified in the Back-up Protection Tests, Section 33.

Paragraph 23.3.10:

The manually resettable or replaceable protective devices specified in 23.3.9 shall be functionally independent of the automatically reset limit control. The following types of controls comply with this requirement:

- A. On or more thermal cutoffs, nonresettable limit controls, or manually resettable limit controls connected to open a sufficient number of ungrounded conductors to permit the unit to comply with the specified temperature limits.
- B. A combination consisting of one or more normally open magnetic contactors and thermal cutoffs, nonresettable limit controls, or manually resettable limit controls. The thermal cutoff or limit control shall be connected in the coil circuit of the contactor. The combination shall be integral with the product; be able to open a sufficient number of ungrounded supply conductors to permit the product to comply with the specified temperature limits; and be independent of control by an automatic cycling device with the unit.

### CONTROLLERS AND DISCONNECTING MEANS

NEC article 424-20:

**(a) Serving as Both Controllers and Disconnecting Means.** Thermostatically controlled switching devices and combination thermostats and manually controlled switches shall be permitted to serve as both controllers and disconnecting means provided all of the following conditions are met:

- (1) Provided with a marked "off" position.
- (2) Directly open all ungrounded conductors when manually placed in the "off" position.
- (3) Designed so that the circuit cannot be energized automatically after the device has been manually placed in the "off" position.
- (4) Located as specified in Section 424-19.

\* Quoted from 1999 NEC and UL Standard 1996.

## HOW BRASCH MEETS REQUIREMENT

Every heater is furnished with an automatic reset thermal cutout of the bimetallic disc type. This device is so located that the airflow through the heater can be either left- or right-hand or vertical up and the device is serviceable without having to remove heater from duct. On larger heaters, where UL requires additional thermal cutouts, these are provided at no extra charge.

Brasch heaters have always had double safety protection as standard and without additional charge. To meet the requirement for a manually replaceable cutoff, a sufficient number of secondary cutouts are provided in every heater. Secondary cutouts are:

1. Factory prewired in the power lines of the heating elements and are not dependent upon back-up contactors or other devices in the control circuit which may fail to open.
2. Spread throughout the terminal box to give protection to the particular elements which they serve. Thus they will sense unsafe conditions even if they occur in the lower portion of the heater.
3. Easily replaced with locally stocked factory replacements once the unsafe condition has been corrected. Unlike the manual reset thermal cutouts which invite being reset without the cause of the unsafe condition having been determined, secondary cutouts, by requiring replacement, point out that something is seriously wrong and must first be corrected.

Brasch heaters are available with optional manual reset thermal cutout and can be wired:

1. In series with the automatic reset thermal cutout (in addition to the secondary cutout which serves as secondary protection),
2. In the power lines (in lieu of secondary cutouts), and
3. To operate back-up contactors.

A secondary cutout and back-up contactor combination is unnecessary since the secondary cutouts are rated to carry the load without need for back-up contactors. A manual reset thermal cutout and back-up contactor combination while optionally available is not recommended for Brasch heaters since secondary cutouts will be provided instead and offer better protection. Back-up contactors are an unnecessary expense.

This requirement means that as long as the thermostat with an off position is not an integral part of the duct heater, a de-energizing contactor as described on page 9 can be used. Disconnecting break contactors are recommended for all applications and some local codes may require them as in Chicago and New York City.

## REQUIREMENT

### **(b) Thermostats That Do Not Directly Interrupt All Ungrounded Conductors.**

Thermostats that do not directly interrupt all ungrounded conductors and thermostats that operate remote control circuits shall not be required to meet the requirements of (a) above. These devices shall not be permitted as the disconnecting means.

UL 1996, Paragraph 26.11

"A contactor or similar device, such as a silicone controlled rectifier required for use with a limit control, shall be provided by the manufacturer of the heater, but need not be mounted on the heater."

### **ZERO CLEARANCE**

UL 1996, Paragraph 44.5

"A duct heater rated 50 kilowatts (kw) or less shall be tested for installation with zero spacing between the duct and combustible surfaces. A duct heater rated more than 50 kw may necessitate that such spacings be larger than zero. See Paragraph 52.2."

### **CONTROL TRANSFORMER CIRCUIT OVERCURRENT PROTECTION**

UL 1996, Paragraphs 20.8 and 20.9

20.8 Except as indicated in paragraph 20.9, a transformer having a rated output of not more than 30 volts and 1000 volt-amperes (National Electrical Code, ANSI/NFPA 70-1984, Class 1, power-limited circuit) shall be protected by an overcurrent device located in the primary circuit. The overcurrent device shall be rated or set at not more than 167 percent of the primary current rating of the transformer. See paragraph 20.10.

20.9 A transformer that directly supplies a National Electrical Code, ANSI/NFPA 70-1984, Class 2 circuit (see paragraph 2.2) shall, in accordance with the Standard for Class 2 and Class 3 Transformers, UL 1585, either limit the output current (inherently limited transformer) or be equipped with an over current device (not inherently limited transformer), and need not comply with the requirements in paragraph 20.8.

### **SUBCIRCUIT OVERCURRENT PROTECTION**

NEC Article 424-22 (b) and (c):

(b) Resistance Elements. Resistance-type heating elements in electric space heating equipment shall be protected at not more than 60 amperes. Equipment rated more than 48 amperes and employing such elements shall have the heating elements subdivided, and each subdivided load shall not exceed 48 amperes. Where a subdivided load is less than 48 amperes, the rating of the supplementary overcurrent protective device shall comply with Section 424-3 (b).

(c) Overcurrent Protective Devices. The supplementary overcurrent protective devices for the subdivided loads specified in (b) above shall be: (1) factory installed within or on the heater enclosure or supplied for use with the heater as a separate assembly by the heater manufacturer; (2) accessible, but shall not be required to be readily accessible; and (3) suitable for branch-circuit protection.

Where cartridge fuses are used to provide this overcurrent protection, a single disconnecting means shall be permitted to be used for the several subdivided loads"

"The overcurrent protective devices required by Paragraph 18.1 shall be provided as an integral part of the heater or shall be provided by the heater manufacturer as a separate assembly, for independent mounting, for use with the heater. See Paragraph 42.15."

### **AIRFLOW**

NEC Article 424-59:

"Air Flow. Means shall be provided to assure uniform and adequate air flow over the face of the heater in accordance with the manufacturer's instructions.

Heaters installed with 4 feet (1.22m) of the outlet of an air-moving device, heat pump, air conditioner, elbows, baffle plates, or other obstruction in duct work may require turning vanes, pressure plates, or other devices on the inlet side of the duct heater to assure an even distribution of air over the face of the heater."

## HOW BRASCH MEETS REQUIREMENT

This paragraph requires that the duct heater manufacturer furnish control, back-up and safety contactors or an SCR controller as part of the heater (either built-in or in a remote control panel) whenever the thermal cutout is incapable of carrying the heater load directly.

Brasch heaters, both slip-in and flanged types, are UL Listed for zero clearance, including those rated over 50 KW (up to 2000 KW maximum). However, it is not recommended that any combustible material be allowed to touch any electric duct heater or immediate surrounding areas.

These requirements mean that when a built-in 120 volt secondary transformer is supplied, it must be provided with primary fusing: when a built-in 24 volt secondary transformer is supplied, it does not require primary fusing unless it is above 100 VA.

To meet this requirement, Brasch heaters were one of the first to offer UL Listed heaters with built-in fuses. Note: NEC requires overcurrent protection only on heaters exceeding 48 amperes total line current. Automatic circuit breakers also meet this requirement.

If overcurrent protection is not ordered built-in, all heaters exceeding 48 amperes total line current must be divided into a sufficient number of subcircuits, each provided with the line terminals for connection to remote overcurrent protection and this remote overcurrent protection must be supplied by the heater manufacturer.

This paragraph requires that the duct heater manufacturer furnish as an integral part of each heater an acceptable means of interlocking the heater with the fan.

# UL/NEC Requirements\* (cont.)

## REQUIREMENT

### HEAT PUMPS AND AIR CONDITIONERS

NEC Article 424-61:

"Installation of Duct Heaters with Heat Pumps and Air Conditioners. Heat pumps and air conditioners having duct heaters closer than 4 feet (1.22m) to the heat pump or air conditioner shall have both the duct heater and the heat pump or air conditioner identified as suitable for such installation and so marked."

### UL (Excerpt from Electrical Appliance and Utilization Equipment List Preface)

Tests have indicated that no adverse thermal effects are obtained when duct heaters marked to indicate that they are suitable for use with heat pumps, or central cooling air conditioners and/or fan-coil units are installed with certain of these units (See Heat Pumps, Central Cooling Air Conditioners and Fan-Coil Units), provided the duct heater is used only in horizontal or upflow systems, and the duct heater is located downstream at least 4 ft. from the nearest surfaces of the heat pump, central cooling air conditioner, or fan-coil unit.

### FAN CIRCUIT INTERLOCK

UL 1996, Paragraph 21.3

"A heater that does not include a fan or blower motor but is intended to be used in conjunction with such motor, such as duct heater, shall be provided with terminals or leads for field connection of an interlock circuit for such motor unless an airflow interlock is provided as an integral part of the heater. The heater shall include the interlocking contacts or the power supply. It shall be so arranged that no heating element circuit can be energized unless the interlocking contacts are closed or the interlocking power supply energized."

NEC Article 424-63:

"Fan Circuit Interlock. Means shall be provided to ensure that the fan circuit is energized when any heater circuit is energized. However, time- or temperature-controlled delay in energizing the fan motor shall be permitted."

### LOCATION OF DISCONNECTING MEANS

NEC Article 424-19:

**"Disconnecting Means.** Means shall be provided to disconnect the heater, motor controller(s), and supplementary overcurrent protective device(s) of all fixed electric space heating equipment from all ungrounded conductors. Where heating equipment is supplied by more than one source, the disconnecting means shall be grouped and identified.

**(a) Heating Equipment with Supplementary Overcurrent Protection.** The disconnecting means for fixed electric space heating equipment with supplementary overcurrent protection shall be within sight from the supplementary overcurrent protective device(s), on the supply side of these devices, if fuses, and in addition shall comply with...

**(1) Heater Containing No Motor Rated Over 1/8 Horsepower.** The above disconnecting means or unit switches complying with section 424-19(c) shall be permitted to serve as the required disconnecting means for both the motor controller(s) and heater under either (a) or (b) below.

- a. The disconnecting means provided is also within sight from the motor controller(s) and the heater; or
- b. The disconnecting means provided shall be capable of being locked in the open position."

NEC Article 424-64:

"Location of Disconnecting Means. Duct heater controller equipment shall be accessible with the disconnecting means installed at or within sight from the controller."

NEC Article 4234-21:

"Switch and Circuit Breaker to Be Indicating. Switches and circuit breakers used as disconnecting means shall be of the indicating type."

## HOW BRASCH MEETS REQUIREMENT

Any UL Listed duct heater must be spaced at least 4 feet from a heat pump or air conditioner unless the combination (i.e., air conditioner with built-in heater) has been Listed by UL.

Heaters are UL Listed for use with heat pumps or air conditioners (no closer than 4 feet between the two).

Any one of the following methods of interlocking the heater with the fan will be provided in Brasch heaters:

1. Built-in airflow switch (wired in series with elements or holding coils of contractors).
2. Built-in fan relay to provide the interlocking contacts mentioned in Paragraph 18.3.
3. Built-in power supply with control transformer primary wired to load size of fan starter.
4. Built-in pneumatic-electric (PE) switch with fan interlocking contacts.

NOTE: We recommend a built-in pressure differential airflow switch wherever practical (minimum total pressure differential in duct must be at least .05" WC). If a built-in airflow switch cannot be used, we recommend a built-in fan relay or transformer interlock.

To meet this requirement, Brasch heaters are available with built-in safety disconnect switches (fused or unfused). These disconnects offer the additional advantage of having an interlocking door handle which prevents terminal box door from being opened unless switch is in the off position. Additionally, switches installed in Brasch remote control panels can be locked in the open position.

NOTE: A combination door interlock switch and contactor can not serve as a disconnecting means since door interlock switches are nonindicating.



## Express Duct Heaters 14 Day Shipment

BRASCH OFFERS 14 DAY DELIVERY ON A WIDE VARIETY OF SPECIFIC SIZES, CAPACITIES AND CONTROL COMPONENTS OF SLIP-IN OPEN COIL DUCT HEATERS. DETAILS OF WHAT IS AVAILABLE UNDER THE *EXPRESS HEATER PROGRAM* ARE COVERED IN BULLETIN A-103.

PLEASE REQUEST A COPY OF BULLETIN A-103 FROM BRASCH CUSTOMER SERVICE DEPARTMENT OR GO TO OUR WEBSITE: [www.braschmfg.com](http://www.braschmfg.com). CLICK "PRODUCTS" AND "ELECTRIC HEATING CAPABILITIES". UNDER "PRODUCT LITERATURE" CLICK "BROCHURE A-103".

OPEN COIL HEATERS NOT COVERED IN A-103 ARE NORMALLY AVAILABLE IN 4 TO 5 WEEKS. HOWEVER, HEATERS NOT COVERED IN A-103, INCLUDING FINNED TUBULAR HEATERS MAY BE AVAILABLE ON AN EXPEDITED BASIS AT MODEST ADDITIONAL CHARGE. CONTACT BRASCH SALES DEPARTMENT.

# Limited Warranty

All Brasch Manufacturing Company, Inc. products covered in this bulletin are warranted against defects in material and workmanship for one year from date of purchase. This warranty does not apply to damage from accident, misuse, alteration; nor where the connected voltage is more than 5% above product nameplate voltage; nor to equipment improperly installed or wired or maintained in violation of installation instructions. This warranty is valid only in the fifty states of the United States. No other written or oral warranty applies. No employee, agent, dealer or other person is authorized to extend the warranty on behalf of Brasch Manufacturing Company.

The customer shall be responsible for all costs incurred in the removal or reinstallation and shipping of the product for repairs. Inoperative units should be returned to Brasch, to the attention of Service Manager for replacement at our option. Product will be returned freight prepaid. Repair or replacement is the exclusive remedy available from Brasch who is not liable for damages of any kind, including incident or consequential damage.

**BRASCH**  
MANUFACTURING COMPANY, INC.  
2310 MILLPARK DRIVE  
MARYLAND HEIGHTS, MO 63043  
(314) 291-0440 • FAX (314) 291-0646  
e-mail: [braschmfg@braschmfg.com](mailto:braschmfg@braschmfg.com)  
internet: [www.braschmfg.com](http://www.braschmfg.com)